

MarSurf



Mobile Surface Roughness Measuring Instruments

High-precision measurement of surfaces – flexible and intuitive
SMAHRT Surf - simple, smart und mobile.

This is what **EXACTLY** means for us.

- 0 +



Your Complete Source for
Testing Equipment Since 1969!

www.BergEng.com
Berg Engineering & Sales Company, Inc.

1-847-577-3980
info@BergEng.com

IN THE PAST THERE WAS THE FINGERNAIL TEST. TODAY, THERE IS MARSURF

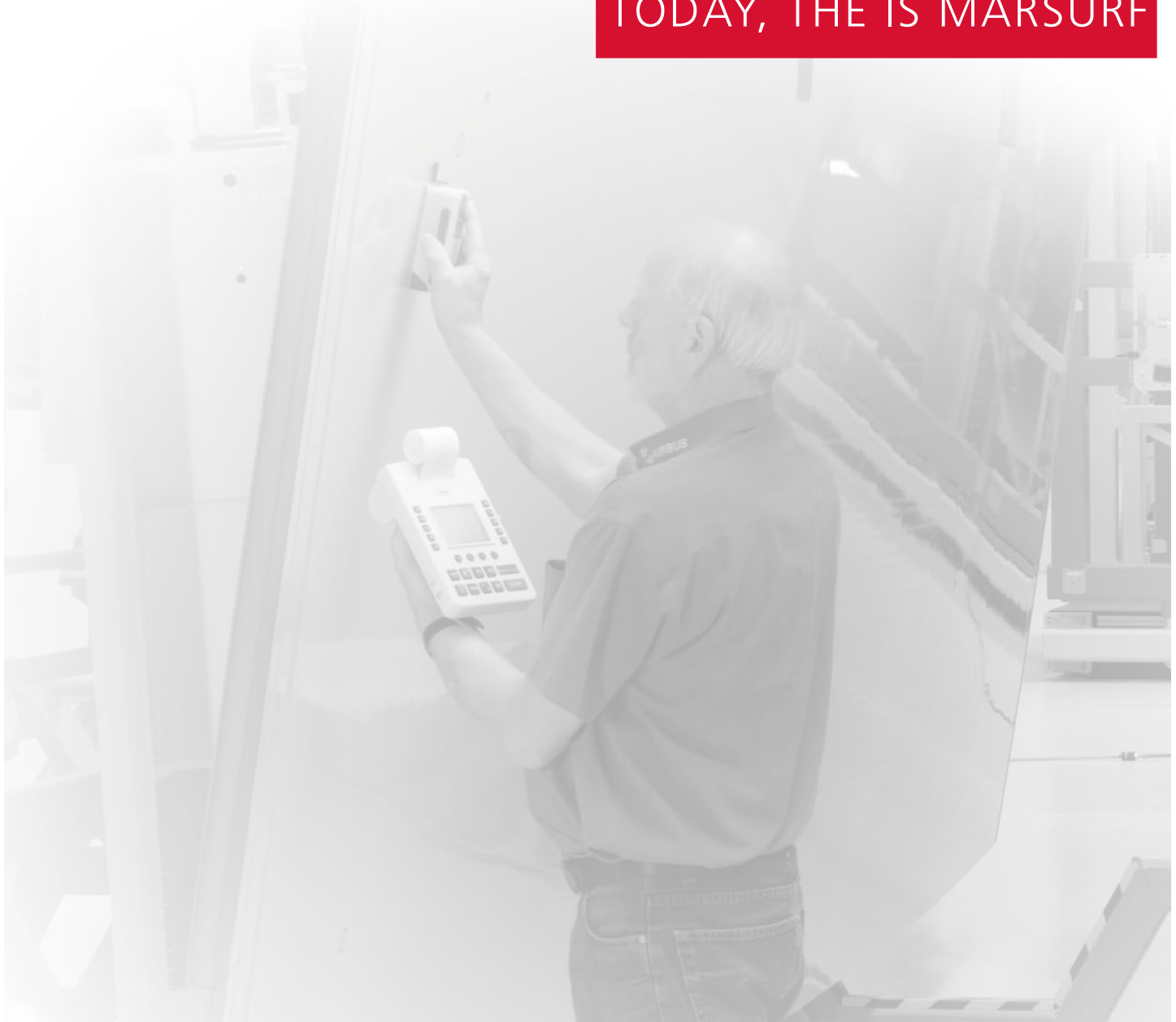

Wherever surface structures influence the function, processing or appearance of components or products, careful testing is essential. But how can surfaces be tested? At the beginning of the 20th Century, experts still had to test by eye and touch. A practiced eye can detect features in the μm range, and even the much maligned thumbnail test delivered perfectly acceptable results. Now however, we live in an age of interchangeable parts and globalization, where subjective tests like this are no longer adequate. Today, computer-aided measuring instruments provide objective data. Measurement and evaluation have become considerably easier. For decades, Mahr has been a worldwide pioneer in this area, as demonstrated by the company's numerous innovations and patented solutions in the field of surface roughness metrology. The interplay between the stylus, drive and measuring setup plays a key role in influencing the quality of surface measurement tasks. This is where Mahr's core expertise comes in, as demonstrated by the company's numerous innovations and patented solutions. Over this time, we have succeeded in perfecting the stylus method, which is now in widespread use throughout the world. We can meet even the most demanding requirements for non-contact measurement, e.g. where extremely soft materials or ultra-short measuring times are involved, thanks to the range of optical sensors offered in the MarSurf product family. Developed with Mahr quality, expertise and know-how, MarSurf is the solution for all your surface metrology needs.



MarSurf. Mobile Surface Roughness Measuring Instruments

- MarSurf PS 10 4
- MarSurf M 300 8
- MarSurf M 300 C 9
- Drive Unit MarSurf RD 18 for MarSurf M 300 / M 300 C 11
- Drive Unit MarSurf RD 18 C2 for Traverse Tracing 11
- Optional Probes for MarSurf PS 10 / M 300 / M 300 C 12
- Accessories for MarSurf PS 10 / M 300 14
- Accessories for MarSurf PS 10 / M 300 / M 300 C 16
- Software for MarSurf PS 10 / M 300 / M 300 C 18
- MarSurf. Available Parameters 19
- MarSurf M 400 20
- MarSurf M 400 C 23
- MarSurf XR 1 24
- Drive Unit RD 18 for MarSurf XR 1 25
- Drive Unit SD 26 for MarSurf XR 1 26
- Drive Unit GD 26 for MarSurf XR 1 27
- MarSurf XR 1. Application Examples 28
- Software and Options for MarSurf XR 1 30
- Probe Arms for Drive Unit MarSurf SD 26 / GD 26 36
- Accessories for MarSurf XR 1 39

MarSurf PS 10 Set

Entry Level Device in Surface Measurement Technology

Mahr's entry-level surface metrology instrument is intuitive and simple to use. The **4.3" TFT touch display** can be turned in any direction.

The **removable drive unit** makes the MarSurf PS 10 flexible in production and manufacturing. One new feature is the integrated but **removable calibration standard**.

Measuring records can be saved in the instrument itself as PDF files. Alternatively, they can be **transferred using MarCom**.



On-site roughness measurement.
Measuring in production with the MarSurf PS 10



Other practical examples using the MarSurf PS 10



MarSurf PS 10 Set

Extremely easy to operate with detailed profile display

The large 4.3" high-resolution and backlit TFT touch display allows intuitive operation (just like a smartphone) and precise representation of the measuring profile.



Flexible use

The removable drive unit, in conjunction with the optional hand-held support, lends this instrument added versatility where space is limited, e.g. in holes or when measuring small parts.



Perfect evaluation and documentation

The PS 10 automatically creates a PDF measuring record without the need for any additional software. The measuring record can be easily transferred to a PC via the USB port.

Alternatively, measuring data can be evaluated in the MarSurf XR 1 and XR 20 roughness software or the measurements can be sent to Excel or SPC programs using the MarCom software.

Mahr	Mahr GmbH	MarSurf PS 10 1.00-12
Erstellungsdatum:	18.05.2016 14:46	Lt: 4,8 mm
Geräte:	MarSurf PS 10 (1126)	Lit: 2,5 µm
Tester:	PHT 350	VB: +/- 200,0 µm
		VT: 1,0 mm/s
		Punkte: 9600
R(L)C ISO 16610-21 0,8 mm]		
Ver 10,0 µm/5sk; Hor 0,8 mm/5sk;		
R(L)C ISO 16610-21 0,8 mm]		
Ra	2,513 µm	0,000 5,400
Rz	18,292 µm	0,000 8,000
Rmax	24,525 µm	0,000 12,000
Rv	5,160 µm	0,000 8,000
Rv	12,123 µm	0,000 13,000
Rt	25,510 µm	0,000 27,000



Always at hand

The calibration standard stays in the instrument and can be checked at any time.



MarSurf PS 10 "SMAHRT Surf"

Easy, smart and mobile



Applications

- On-site surface roughness measurement
- Measuring during the production process
- Universal use on processing machinery
- For incoming goods inspection

Additional version with transverse drive unit MarSurf PS 10 C2 available.

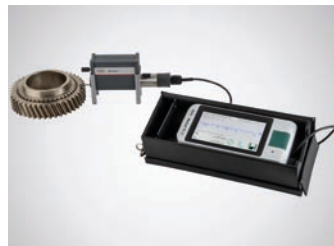

Features

- Small and lightweight; ideal as mobile surface roughness measuring instruments
- Large illuminated 4.3" TFT touch display
- Display can be rotated
- Simple to operate (smart-phone!)
- Increased flexibility due to the removable drive unit
- Start button is simultaneously the home button for direct access to the start screen
- Direct access to your customized functions with favorites
- 31 parameters: offer the same range of functions as a laboratory instrument
- Data is saved in the device, e.g. TXT, X3P, CSV and PDF file
- Evaluation of most common parameters conforming to standards and in accordance to ISO /JIS as well as parameter lists
- Integrated, removable roughness standard for the standard pick-up PHT 6-350
- Dynamic calibration function
- Select standards (DIN-ISO/ JIS/ASME /MOTIF)
- Automatic cutoff selection (patented) to ensure correct measuring results
- Individual sampling lengths and shortened cutoff can be selected
- Setting of unsymmetric intersection lines for peak count calculation
- Phase-correct profile filter (Gaussian filter) acc. to DIN EN ISO 16610-21 (before DIN EN ISO 11562), special filter acc. to DIN EN ISO 13565-1, ls-filter acc. to DIN EN ISO 3274 (disengageable)

- Tolerance monitoring
- Lock settings and/or password protection
- Date and/or time of measurement
- Integrated memory to store approx. 500000 results, 3900 profiles and 1500 pdf-files
- Data transmission via the USB interface to a PC or via microSD-Card
- MarConnect interface, to connect e.g. a PC via the MarCom Software
- Main free operation: the built-in rechargeable battery can be used for up to 1200 measurements before being recharged

Supplied with:

- MarSurf PS 10 base unit
- Drive unit (removable)
- 1 standard pick-up PHT 6-350 (conforming to standards)
- Built-in battery
- Roughness standard integrated (removable) into base unit incl. Mahr calibration certificate
- Pick-up protection
- Charger / mains adapter with 3 mains power adapters
- Operating instructions
- Carrying case with shoulder strap
- USB cable
- Extension cable drive unit
- Height adjustment accessory (integrated)

MarSurf PS 10 "SMAHRT Surf"

Technical data

MarSurf PS 10		
Unit of measurement		Metric / inch
Measuring principle		Stylus method
Pick-up		Inductive skidded pick-up, 2 µm (80 µin) stylus tip, measuring force ca. 0.7 mN
Parameters	DIN / ISO	Ra, Rq, Rz, Rmax, Rp, Rpk, Rk, Rvk, Mr1, Mr2, A1, A2, Vo, Rt, R3z, R _{PC} , R _{mr} , R _{Sm} , R _{sk} , CR, CF, CL, R, AR, Rx
	JIS	Ra, Rq, Ry (equiv. to Rz), RzJIS, tp (equiv. to R _{mr}), R _{Sm} , S
	ASME	Rp, R _{pm} , R _{PC} , R _{sk} , tp (enquir. to R _{mr})
	MOTIF	R, AR, Rx, CR, CF, CL
Languages		English, German, French, Italian, Spanish, Portuguese, Dutch, Swedish, Czech, Polish, Russian, Japanese, Chinese, Korean, Turkish, Hungary, Romanian
Measuring range		350 µm
Profile resolution		8 nm
Filter*		Phase-correct profile filter (Gaussian filter) according to DIN EN ISO 16610-21 (before ISO 11562) Special filter according to DIN EN ISO 13565-1, Is filter according to DIN EN ISO 3274 (can be disabled)
Cutoff lc*	mm (inch)	0.25 / 0.8 / 2.5 (0.010" / 0.030" / 0.100"); automatic
Traversing length Lt*	mm (inch)	1.5/ 4.8 /15 (0.06" / 0.192" / 0.6"); automatic
Traversing length (according to MOTIF)	mm (inch)	1 / 2 / 4 / 8 / 12 / 16 (0.040" / 0.080" / 0.160" / 0.320" / 0.480" / 0.640")
Short cutoff*		Selectable
Evaluation length ln*	mm (inch)	1.25 / 4.0 / 12.5 (0.050", 0.15", 0.50")
Number n of sampling lengths*		Selectable: 1 to 16
Calibration function		Dynamic
Memory		3900 profiles, 500000 results, 1500 pdf-files, memory can be extended with microSD-Card up to 32 GB
Additional functions		Lock settings / password protection, Date/Time
Dimensions	mm (inch)	160 × 77 × 50 (6.29" × 3.03" × 1.97")
Weight		500 g (1.10 lbs)
Rechargeable battery		Li-ion battery, 3,7 V, rating 11,6 Wh
Interfaces		USB-Device, MarConnect (RS232, USB), micro SD Slot for SD™ / SDHC-Cards up to 32 GB
Long-range power supply		100 V to 264 V
Order no.		6910230
Order no.	PS 10 Set PS 10 (5 µm probe tip)	6910232
Order no.	PS 10 C2 Set	6910235

* in accordance to ISO/JIS



MarSurf M 300



MarSurf M 300

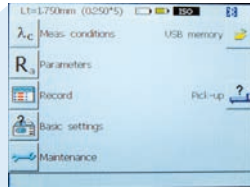

MarSurf RD 18

Applications

- On shafts, housing parts
- On large scale machines
- For large workpieces
- On milling and turning parts
- For use on grinding and honing components
- On the production line, or directly upon a machine. Ideal for rapid testing of the surface roughness of a workpiece in or on a machine
- A simple universal measuring station for checking surface roughness



Features

- Bluetooth wireless connection between the evaluation unit and drive unit (up to 4 m)
- Bright, illuminated color display
- Automatic selection of filter and traversing length conforming to standards
- Integrated thermal graphics printer of high print quality
- Print the R-profile via the thermal graphics printer
- Printed log either by pressing a button or automatically
- Data transfer of results and profiles via USB-interface to your PC
- Evaluation of most common parameters conforming to standards and in accordance to ISO/JIS as well as characteristic curves, parameter lists (e.g. material ratio curve)
- Printing of R-profile (ISO/ASME/JIS), P-profile (MOTIF), material ratio curve, measuring record
- Measuring units ($\mu\text{m}/\mu\text{inch}$) and standards (ISO/JIS/ASME/MOTIF) are selectable
- Tolerance monitoring
- Integrated memory for the results of up to 40000 measurements and 30 profiles
- Setting of unsymmetric intersection lines for peak count calculation
- Individual sampling lengths and short cutoff can be selected
- Key pad lock and/or password protection for instrument settings
- Built-in rechargeable battery with power management
- Integrated roughness standard for the standard pick-up PHT 6-350
- Dynamic calibration function
- Date and/or time of measurement
- Software MarSurf PS1/ M 300 Explorer for recording measurements (option)
- Evaluation unit M 300, drive unit RD 18 with integrated roughness standard, standard pick-up PHT 6-350/2 μm (conforming to standards), charger / mains adapter with 3 mains power adapters, height adjustment accessory, pick-up protection, pick-up protection with prismatic underside, end face vee-block, 2 x USB cables, 1 roll of thermal paper, shoulder strap, carrying case, Mahr calibration certificate, operating instructions

MarSurf M 300 C

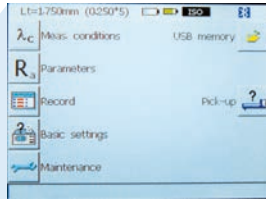

MarSurf M 300 C

MarSurf RD 18 C
+ Handheld Vee block (detachable)

Applications

- On shafts, housing parts
- On large scale machines
- For large workpieces
- On milling and turning parts
- For use on grinding and honing components
- On the production line, or directly upon a machine. Ideal for rapid testing of the surface roughness of a workpiece in or on a machine
- A simple universal measuring station for checking surface roughness



Upside down measurement

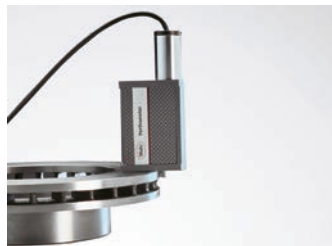

Measurement on an end face vee

Features

- Bright, illuminated color display
- Automatic selection of filter and traversing length conforming to standards
- Integrated thermal graphics printer of high print quality
- Easy to use due to the large color display and the operator guidance
- Printing of R-profiles with the thermo printer
- Printed log either by pressing a button or automatically
- Data transfer of results and profiles via USB-interface to your PC
- Evaluation of most com-

- mon parameters conforming to standards and in accordance to ISO/JIS as well as characteristic curves, parameter lists (e.g. material ratio curve)
- Printing of R-profile (ISO/ASME/JIS), P-profile (MOTIF), material ratio curve, measuring record
- Measuring units ($\mu\text{m}/\mu\text{inch}$) and standards (ISO/JIS/ASME/MOTIF) are selectable
- Integrated memory for the results of up to 40000 measurements and 30 profiles
- Tolerance monitoring
- Setting of unsymmetric intersection lines for peak

- count calculation
- Cylindrical drive unit with handheld vee block and PHT pick-up protection
- Individual sampling lengths and short cutoff can be selected
- Lock instrument settings
- Date and/or time of measurement
- Can be expanded to be an stationary measuring station
- Software MarSurf PS1/ M 300 Explorer for recording measurements (option)

Supplied with:

- Evaluation unit M 300 C, cylindrical drive unit RD 18 C incl. 1.8 m data connection cable, handheld vee block with height adjustable feet, standard pick-up PHT 6-350/2 μm (conforming to standards), roughness standard PRN 10 with Mahr calibration certificate, 1 roll of thermal paper, pick-up protection with prismatic underside, dia. 8 mm mounting clamp for drive unit, charger / mains adapter with 3 mains power adapters, 1 x USB cable (for connection to a PC), shoulder strap, carrying case, operating instructions

MarSurf M 300 / M 300 C

Technical Data

MarSurf M 300 / M 300 C		
Measuring principle		Stylus method
Traversing speed	mm (inch)	0.5 mm/s (0.02 "/s)
Measuring range		350 µm (0.014")
Profile resolution		8 nm
Filter		Gaussian filter, Ls-Filter (switchable)
Cutoff	mm (inch)	0.25, 0.8, 2.5 (0.010", 0.032", 0.100")
Short Cutoff		selectable
Traversing lengths as per DIN / ISO / ASME / JIS	mm (inch)	1.75, 5.6, 17.5 (0.070", 0.2242, 0.700")
Traversing lengths as per EN ISO 12085 (MOTIF)	mm	1, 2, 4, 8, 12, 16
Evaluation lengths	mm (inch)	1.25, 4, 12.5 (0.05", 0.16", 0.5")
Number of sampling lengths selectable		1-5
Parameters	DIN / ISO: JIS: ASME: MOTIF:	Ra, Rq, Rz, Rmax, Rp, Rv, Rpk, Rk, Rvk, Mr1, Mr2, A1, A2, Vo, Rt, R3z, R _{Pc} , R _{mr} , R _{Sm} , R _{Sk} , R, AR, Rx, W, CR, CF, CL Ra, Rq, Ry (equiv. to Rz), RzJIS, Rp, Rv, Rpk, Rk, Rvk, Mr1, Mr2, A1, A2, Rt, tp (equiv. to R _{mr}), R _{Sm} , R _{Sk} , S, R, AR, Rx, W, CR, CF, CL RpA, R _{Pm} , R _{mr} , R _{Sm} , R _{Sk} R, AR, Rx, W, CR, CF, CL
Vertical scale		Automatic/selectable
Horizontal scale		Depending on the cutoff
Record contents		R -profile, MRK, P-profile (MOTIF), results
Printing		Automatic/manual Record with time
Calibration function		Dynamic
Memory		Integrated memory For the storage up to 40000 measurements and up to 30 profiles
Measuring units		µm/µinch selectable
Languages selectable:		English, German, French, Italian, Spanish, Portuguese, Dutch, Swedish, Czech, Polish, Russian, Japanese, Chinese, Korean, Turkish
Blocking instrument settings		Yes
Password protection		Yes
LCD		High resolution color display, 3.5", 320 x 240 pixel
Printer		Thermal printer, 384 points/horizontal line, 20 characters/line
Printing speed		ca. 6 lines/second corresponds to approx. 25 mm/s (1 "/s)
Thermal paper		Dia. 40.0 mm-1.0 mm, width 57.5 mm-0.5 mm, coated
Interface		USB, MarConnect
Power supply		NiMH battery, capacity: approx. 500 measurements (depending on the number and length of record printouts), plug-in power pack with three mains plugs, for input voltages from 90 V to 264 V
Power management		Yes
Connections		Drive unit, power pack, USB, MarConnect
Protection class	M 300 / M 300 C RD 18 / RD 18 C	IP 42 IP 40
Temperature range for storage		-15°C to +55°C (5°F to 131°F)
Temperature range for operation		+5°C to +40°C (41°F to 104°F)
Relative humidity		30 % to 85 %
Dimensions (L x W x H)	M 300 / M 300 C	190 x 140 x 75 mm (7.5" x 5.5" x 3")
Dimensions (L x W x H)	RD 18	130 x 70 x 50 mm (5.1" x 2.7" x 2")
Dimensions (L x dia.)	RD 18 C	139 x 26 mm (5.5" x 1")
Dimensions (L x W x H)	RD 18 C*	82 x 34 x 59 mm (3.2" x 1.3" x 2.3")
Weight	M 300 / M 300 C RD 18 RD 18 C RD 18 C*	ca. 1 kg ca. 300 g ca. 165 g ca. 55 g
Order no.	M 300 Set	6910401
Order no.	M 300 C Set	6910431

Drive Unit for MarSurf M 300 / M 300 C

Drive Unit MarSurf RD 18 for M 300

Bluetooth-Technology

Unique: Cable-free connection between evaluation unit and drive unit!

A further advantage is the connection of several drive units to only one evaluation unit



Features

- The well-proven PHT-skid probes are implemented in the drive unit.
- Can be connected via a cable

Supplied with:

Drive unit RD 18 with integrated roughness standard

Technical Data

Tracing direction	Longitudinal
Traversing length as per DIN/ISO	adjustable on M 300 1.75 mm, 5.6 mm, 17.5 mm (0.07", 0.22", 0.7")
as per EN ISO 12085	1 mm, 2 mm, 4 mm, 8 mm, 12 mm, 16 mm
Traverse speed	0.5 mm/s
Dimensions (w/o pick-up protection)	dia. 24 mm, L = 112 mm
Bluetooth range	up to 4 m
Order no.	6910403

MarSurf RD 18 C2 for Transverse Tracing for M 300 C / PS 10



Features

- During the manufacturing process, surface measurements of work pieces usually require special tools to find the right solution for a particular task; e.g. transverse scanning on a crank or camshafts, or measuring bearings. For such tasks the drive unit RD 18 C2 is available for transverse scanning.
- The well-proven PHT-skid probes are implemented in the drive unit.
- The drive unit RD 18 C2 is attached in the same way as the RD 18.
- By being able to use both types of drive units the range of application offered by the mobile MarSurf M 300 C and MarSurf PS 10 is broadened.

Supplied with:

Drive unit RD 18 C2, pick-up protection with prismatic underside, pick-up protection and a screwdriver

Technical Data

Tracing direction	Transverse
Traversing length as per DIN/ISO	adjustable on M 300 1.75 mm, 5.6 mm (0.07", 0.22")
as per EN ISO 12085	1 mm, 2 mm, 4 mm
Traverse speed	0.1 mm/s and 0.5 mm/s
Dimensions (w/o pick-up protection)	dia. 24 mm, L = 142 mm
RD 18 C2	Order no. 6910426
Chuck for RD 18 C2 for Ø 5 mm to Ø 80 mm	Order no. 6850738

Optional Probes for MarSurf PS 10 / M 300 / M 300 C

Probes for various measuring tasks

The P-probes are characterized by special construction features:

- Stylus tip geometry as per EN ISO 3274, standard 2 µm/90°
- Measuring force of approx. 0.7 mN (as per EN ISO 3274)
- Reliable inductive converter
- Robust, rigid housing
- Self-aligning, elastic bearings
- Reliable plug and socket connections

Pick-up PHT 6-350 (standard probe)



System	Single-skid pick-up with spherical skid
Skid radius	in traversing direction 25 mm (.984"), at right angles 2.9 mm (.114")
Contact point	0.8 mm (.0315") in front of the stylus
Meas. range	350 µm (0.014")
Specification	for plane surfaces, bores with a dia. larger than 6 mm (.236") and a max. depth of 17 mm (.669"), grooves with a width larger than 3 mm (.118"); min. workpiece length = traversing length + 1 mm (.0394")
Order no.	6111520*

*Included in the scope of supply

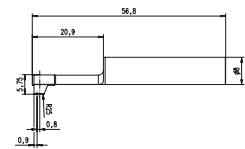

Pick-up PHT 11-100



System	Single-skid pick-up with spherical skid
Skid radius	in traversing direction 25 mm (.984"), at right angles 2.9 mm (.114")
Contact point	0.8 mm (.0315") in front of the stylus
Meas. range	100 µm (.00394")
Specification	for plane surfaces, bores with a dia. larger 14 mm (.551"), grooves with a width larger than 2.5 mm (.098")
Order no.	6111524

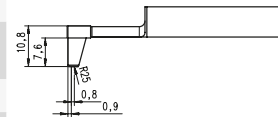

Pick-up PT 150



System	Dual-skid pick-up with spherical skid
Skid radius	in traversing direction 50 mm (1.969"), at right angles 3 mm (.118")
Contact point	4.5 mm (.177") in front of the stylus
Meas. range	150 µm (.006")
Specification	for measurements on metal sheets and roller min. workpiece length = tracing length + 5 mm (.197")
Order no.	6111523

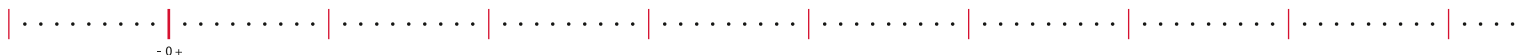
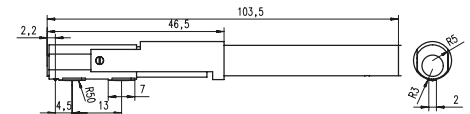

Optional Probes for MarSurf PS 10 / M 300 / M 300 C

Pick-up PHT 3-350



System	Single-skid pick-up with spherical skid
Skid radius	in traversing direction 25 mm (.984"), at right angles 1.45 mm (.0571")
Contact point	0.9 mm (.0354") in front of the stylus
Meas. range	350 µm (0.014")
Specification	for bores with a dia. larger than 3 mm (.118") and a max. depth of 17 mm (.669") min. workpiece length = traversing length + 1 mm (.0394")
Order no.	6111521

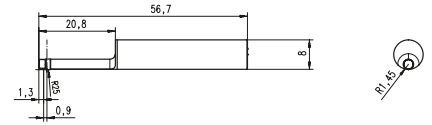

Pick-up Extension PHT (80 mm) for P probes



Order no. 6850540

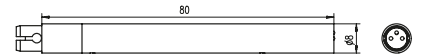

Pick-up PHTF 0.5-100



System	Single-skid pick-up with spherical skid
Skid radius	in traversing direction 25 mm (.984"), at right angles 1.45 mm (.0571")
Contact point	0.6 mm (.0236") at the side the stylus
Meas. range	100 µm (.00394")
Specification	e.g. for gear tooth flanks with a modulus larger than 0.8
Calibration	via Geometric standard PGN
Order no.	6111522

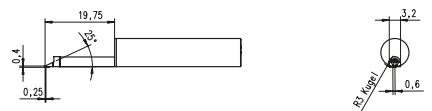

Pick-up PHTR-100



System	Single-skid pick-up with lateral, spherical skid
Skid radius	in traversing direction 0.3 mm (.012")
stylus radius	2 µm (.0008"), 90°
Specification	for measurements on concave and convex surfaces
Calibration	via Geometric standard PGN
Order no.	6111525

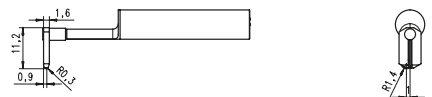

Accessories for MarSurf PS 10 / M 300

Measuring Stand MarStand 815 GN

MarStand measuring stands offer high stability which ensures precise measurements.

- Rugged base ensures both maximum stability and sturdiness
- The upper side of the base has a convenient hand grip
- Support arm can be finely adjusted

Total height with base	Order no.
300 mm	4413000
500 mm	4413001
750 mm	4413005



Stand Adapter for MarSurf PS 10 / RD 18 C

Mount for cylindrical drive unit PS 10 / RD 18 C on measuring stand / height measuring instrument Ø 8 mm

	Order no.
Stand adapter for MarSurf PS 10 / RD 18 C	6910435



Hand-held Support for MarSurf PS 10 / RD 18 C

The hand-held support with its multiple contact surfaces offers various application possibilities.

	Order no.
Hand-held support for MarSurf PS 10 / RD 18 C	6910434
Height adjustment device suitable for hand-held (pair)	6850720



Pick-up Protection for PS 10 / RD 18 / RD 18 C

	Order no.
Pick-up protection, steel	6850716
Pick-up protection with header vee-block, steel	6850715
Pick-up protection, plastic*	7028532
Pick-up protection header vee-block, plastic**	7028530

* With M 300 Set included in the scope of supply

** With M 300 and M 300 C Set included in the scope of supply

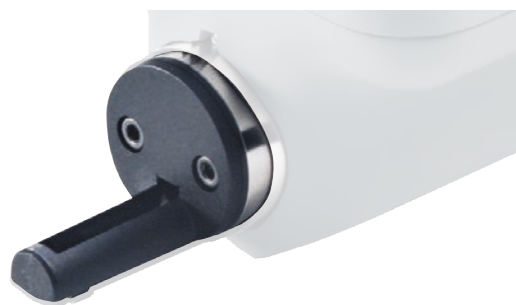

Illustration: 7028532



Accessories for MarSurf PS 10 / M 300

Mounting Bracket for 814 SR

		Order no.
814 Sh	Adjustable mounting bracket to connect the PS 10 / RD 18 to a 814 SR	2247086



814 Sh



RD 18



PS 10

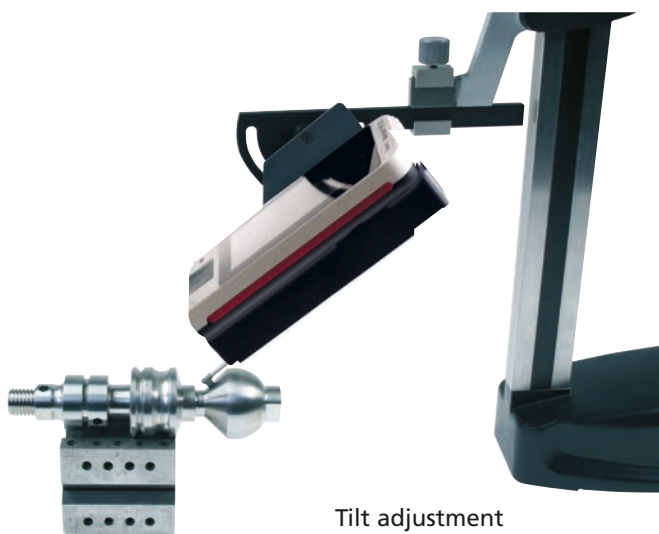

Tilt adjustment

Height Measuring and Scribing Instrument Digimar 814 SR for MarSurf PS 10 / RD 18



REFERENCE



Funktionen:

RESET (Set the display to zero for relative measurement), ABS (Switch between relative and absolute measurement), mm/inch, Reference-Lock/Unlock, PRESET (to enter a numerical value), DATA (Data transmission via connection cable), Auto-ON/OFF

- Max. measuring speed 1.5 m/s (60"/s)
- High contrast Liquid Crystal Display with 12 mm high digits
- Sturdy heavy-duty base, easy to handle
- Hardened and lapped contact surface which produce both a smooth and even movement
- Slide and beam made of hardened stainless steel
- Hand crank for positioning and measuring
- Fine adjustment
- Locking screw
- Interchangeable scriber point, carbide tipped

Supplied with:

Scriber point, cardboard box, battery and operating instructions

		Order no.
814 SR	Measuring range 350 mm	4426100
814 SR	Measuring range 600 mm	4426101



Accessories for MarSurf PS 10 / M 300 / M 300 C

Mount for Measuring Stand ST

Accessories for measuring stands (these are not included in the measuring stands scope of supply):

Mount for MarSurf PS 10 / RD 18

The drive unit RD 18 can in the mount be pivoted and locked in any position ($\pm 15^\circ$)

Order no. **6910201**

Mount for MarSurf RD 18 C

The drive unit RD 18 C can in the mount be pivoted and locked in any position ($\pm 15^\circ$)

Order no. **6851304**



Illustration: 6910201

Measuring Stands ST

Measuring stand ST-D

Height adjustment	0 to 300 mm, with a hand wheel
Dimensions (L x W x H)	175 x 190 x 385 mm
Weight	ca. 3 kg
Order no.	6710803



ST-D

Measuring stand ST-F

Grante plate. The required measuring height can be adjusted with a hand wheel for convenient and accurate positioning of the drive unit.

Height adjustment	0 to 300 mm, with a hand wheel
Dimensions (L x W x H)	400 x 300 x 415 mm
Weight	ca. 35 kg
Order no.	6710806



ST-F

Measuring stand ST-G

Grante plate with a 10 mm (.39 in) T-slot for mounting work pieces. The required measuring height can be adjusted with a hand wheel for convenient and accurate positioning of the drive unit.

Height adjustment	0 to 300 mm, with a hand wheel
Dimensions (L x W x H)	500 x 300 x 415 mm
Weight	ca. 35 kg
Order no.	6710807



ST-G



Accessories for MarSurf PS 10 / M 300 / M 300 C

Vee-block PP

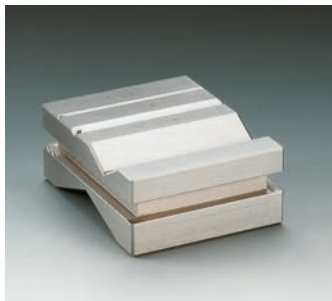

With four different prisms for mounting axis-symmetrical workpieces with diameters from 1 mm to 160 mm (.0394" to 6.30").

Dimensions (L x W x H)
80 x 100 x 40 mm
3.91" x 3.15" x 1.58"

Weight 1.5 kg / 3.31 lb

Including clamping springs for holding light workpieces in the prism.

Order no. 6710401

XY Table CT

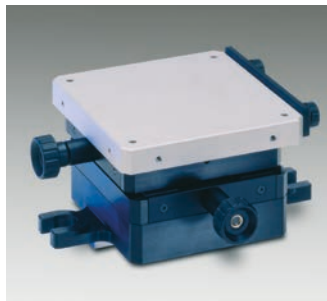

For mounting and aligning workpieces. Can be adjusted in two coordinates by 15 mm (.591").

Table surface 120 x 120 mm
Table surface 4.728" x 4.728"
with two brackets.

Order no. 6710529

Parallel Vice PPS

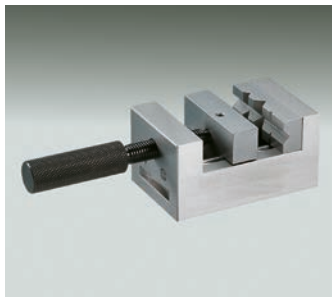

For mounting rectangular and cylindrical workpieces

Jaw width 70 mm / 2.76"

Jaw height 25 mm / .984"

Span 40 mm / 1.58"

Total height 58 mm / 2.28"

Weight 2 kg / 4.41 lb

Order no. 6710604

Mini Precision Vice 109 PS as Set



With mini precision vices. Depending on the version with prism jaws, carrier plates, stands and mini dividing attachment. Included in a plastic case

Width of jaws 15 / 25 / 35 mm
Width of jaws 15 / 25 / 35 mm

Order no. 4246819

Roughness Standard PRN 10



With Mahr calibration certificate. Roughness standard with turned profile, chromed. Profile depth ca. 10 µm (.394 µinch), for checking the roughness measuring station

Order no. 6820420*

* With the M 300 C Set this is included in the scope of supply.

Geometric Standard PGN



Surface standard with sinusoidal groove profile for dynamic monitoring of the roughness measuring station. Ra, Rz, Rmax.

Optical flat. The following versions are available:

		Order no.
PGN 1	Profile depth ca. 1.5 µm (60 µinch), groove distance ca. 0.10 mm (0.0039")	6820602
PGN 3	Profile depth ca. 3 µm (120 µinch), groove distance ca. 0.12 mm (0.0047")	6820601
PGN 10	Profile depth ca. 10 µm (394 µinch), groove distance ca. 0.20 mm (0.0079")	6820605
Mahr Calibration Certificate for PGN		9027715
DKD (German Calibration Service) Calibration Certificate for PGN		6980102

Accessories for MarSurf PS 10 / M 300 / M 300 C

MarCom Software for PS 10 / M 300 / M 300 C

Software MarCom Professional

- Measured values can be directly transferred into MS Excel (from version 97) or into a text file or key code
- The measured values from each instrument can be sent to a different column, table or folder in Excel
- Data transmission via USB and/or 2 serial COM interfaces
- Flexible and comfortable data transmission: you can either press the "Data" button on the measuring instrument or on the data cable; via a computer keyboard, timer; or by activating a foot switch connected to an USB interface

Software MarCom Standard

(included with the USB Data Cable, for free download)

Features and system requirements are identical to MarCom Professional, except that it only has one USB and one serial COM interface.

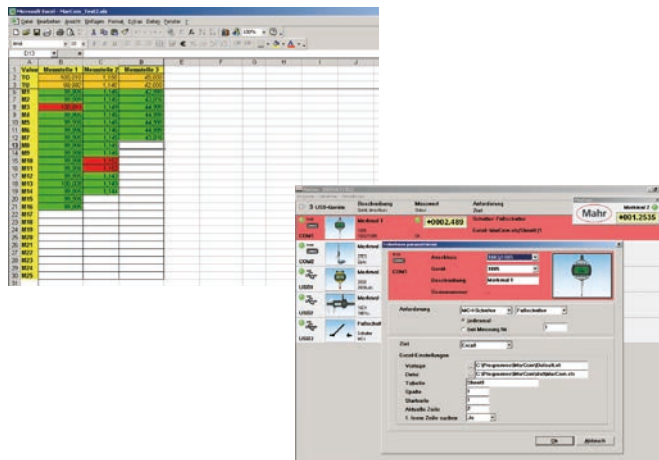

	Order no.
Software MarCom Professional	4102212
Data Cable 16 EXu incl. MarCom Standard	4102357

Evaluation Software MarWin EasyRoughness

- An easy way to evaluate and document data based on MarWin
- Evaluation and documentation of the results can be conducted independently and away from the measuring station
- Filing including documentation is made simple
- Workstation version available

Order no.

6299054

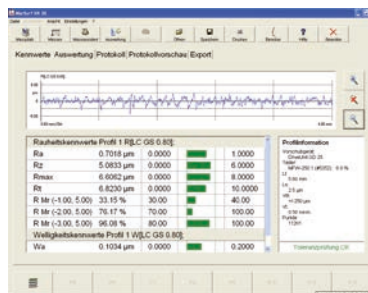

MarSurf. Available Parameters

Parameters for MarSurf PS 10 / M 300 / M 300 C

Parameter	Output	Meaning	Standards
Ra	RA	Arithmetic mean roughness Ra	
Rq	RQ	Root mean square roughness Rq	
Rz Ry (JIS) corr. to Rz	RZ	Mean peak-to-valley height Rz (acc. to ISO) or Ry (acc. to JIS)	DIN EN ISO 4287 : 1998; ISO 4287 : 1997; JIS B 0601 : 2001
Rz (JIS)	RZJ	Mean height Rz of profile elements	JIS B 0601 : 2001 (früher: ISO 4287/1 : 1984)
Rmax	RMAX	Maximum roughness depth Rmax	DIN 4768 : 1990
Rp	RP	Mean profile peak height Rp	DIN EN ISO 4287 : 1998; ISO 4287 : 1997
RpA (ASME)	RP	Maximum profile peak height Rp	
Rpm (ASME)	RPM	Mean profile peak height Rp	ASME B46
Rpk	RPK	Reduced peak height Rpk	
Rk	RK	Core roughness depth Rk	
Rvk	RVK	Reduced valley depth Rvk	
Mr1	MR1	Smallest material ratio Mr1 of roughness core profile	
Mr2	MR2	Largest material ratio Mr2 of roughness core profile	DIN EN ISO 13565-2 : 1998
A1	A1	Material-filled profile peak area A1	
A2	A2	Lubricant-filled profile valley area A2	
Vo	VO	Oil-retaining volume Vo	
Rt	RT	Total height Rt of R-profile	DIN EN ISO 4287 : 1998
R3z	R3Z	Arithmetic mean third peak-to-valley R3z	DB N 31007 : 1983 (only MarSurf M 300/ M 300 C)
RPc	RPC	Peak count RPc is the number of profile elements (see Rsm) per cm that exceed the set upper profile section level c1 and then fall short of the lower c2.	EN 10049 : 2005; ASME B46
Rmr tp (JIS, ASME) corr. to Rmr	RMR	Material ratio Rmr	DIN EN ISO 4287 : 1998; ISO 4287 : 1997; JIS B 0601 : 2001
RSm	RSM	Mean width RSm of profile elements (previously: groove spacing)	
Rsk	RSK	Skewness Rsk of the profile	DIN EN ISO 4287. ASME B46.1
S	S	Mean spacing S of local profile peaks	JIS B 0601 : 1994
CR	CR	Zone width CR of the profile peak zone (French „critère de rodage“) (dependent on intersection lines Scr1 and Scr2)	
CF	CF	Zone width CF of the profile core zone (French „critère de fonctionnement“) (dependent on intersection lines Scf1 and Scf2)	cf. P8c (Pdc) in: DIN EN ISO 4287 : 1998 ISO 4287 : 1997 JIS B 0601 : 2001
CL	CL	Zone width CL of the profile valley zone (French „critère de lubrification“) (dependent on intersection lines Scl1 and Scl2)	
R	R	Mean depth R of roughness motifs	
Ar	AR	Mean width Ar of roughness motifs	
Rx	RX	Maximum depth Rx of profile irregularity	ISO 12085 : 1996

Additional Parameters MarSurf M 300 / M 300 C

Rv	Rv	Mean profile valley depth Rv	DIN EN ISO 4287 : 1998 ISO 4287 : 1997 JIS B 0601 : 2001
W	W	Mean depth W of waviness motifs (dependent on operators A and B)	DIN EN ISO 12085 : 1998 ISO 12085 : 1996 JIS B 0631 : 2000



MarSurf M 400

The best of the "Mobiles". High performance with high mobility

Evaluation Unit MarSurf M 400



Easy. Fast. Innovative

Not only needed in the measuring room but also more and more often in the production area: Surface evaluation that requires skidless tracing.

This generally means higher demands of the operator qualification, more time, more adjustments.

MarSurf M 400 offers this required performance scope in its line of mobile surface metrology – with easy and fast operation

Probe System BFW 250



1



2



3

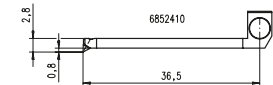
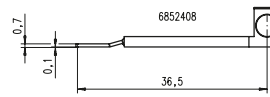
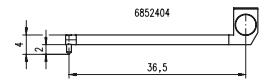
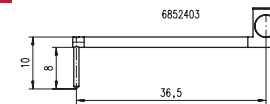

4

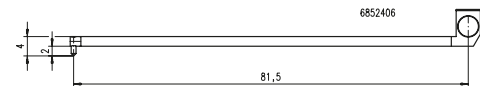

MarSurf SD 26

- **Skidless tracing** with high precision probe system (1)
- **Fast probe arm change** due to magnetic probe arm holder (2, 3, 4)
- **Protection from damage**
- **Only a few seconds of setting time required** due to motorized height adjustment of the drive unit with automatic zero setting
- **Flexible handling** with cable-free Bluetooth connection
- **Concise, clear and easy** due to brilliant color display for the depiction of results and operator guidance
- **Mobile use** due to operation with AC adapter or built-in battery
- **Internationally up to date** with all common parameters as per ISO, JIS, ASME, many integrated languages
- **Documentation with quality** with integrated thermal printer for printout of profile and results
- **Standardized measuring** point density despite increased measuring speed

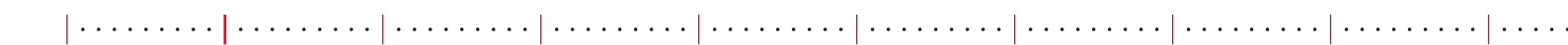

MarSurf M 400

Applications MarSurf M 400



Upside down measurement with vee-block
Automatic zero setting of the BFW 250



Measurement in production



MarSurf measuring station with measuring stand ST-G

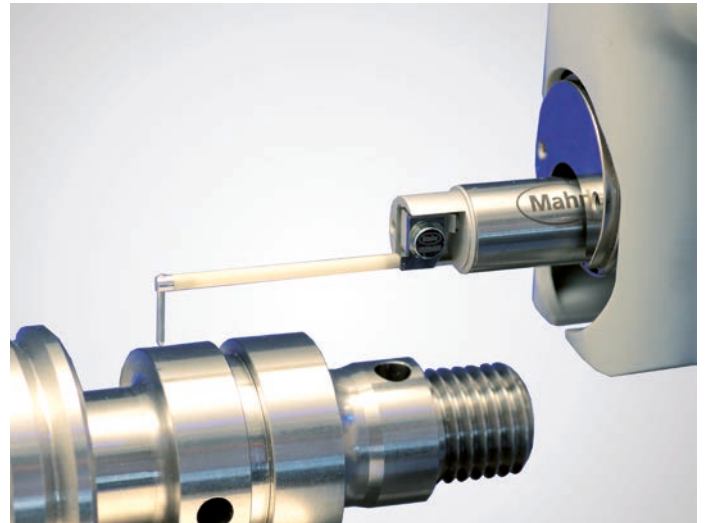

The possibility to expand the mobile surface measuring unit to a small stationary work station can be easily and quickly realized by adding only a few components from the line of MarSurf accessories.

Fast and easy alignment of the drive unit relative to the test-piece thanks to the inclination adjustment option.

The MarSurf M 400 enables the evaluation of parameters from the P, W and R profiles.

P profile

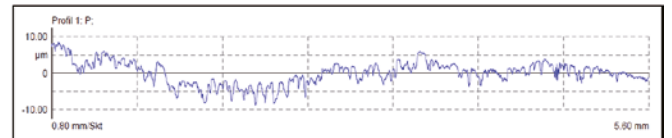

W profile

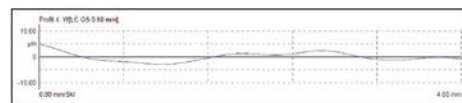

R profile

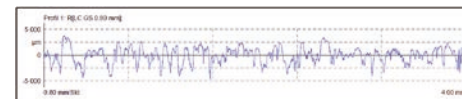

MarSurf M 400 Set



Scope of delivery

- Evaluation unit MarSurf M 400
- Drive unit MarSurf SD 26 incl. probe system BFW 250
- Standard probe arm (6852403)
- 1 thermo paper roll
- Wide-range AC adapter mit 3 adapters
- 2 x USB cables (to connect to PC and for use with cable)
- Operating instructions

All items are delivered in a practical carrying case.

MarSurf M 400 Set:

Order no. 6910404

MarSurf M 400 Set	
Profile determination	Primary, waviness and roughness profile
Probe	Inductive skidless probe system with exchangeable probe inserts, 2 µm probe arm, measuring force approx. 0.7 mN (standard)
Filters (as per DIN/JIS)	Gaussian filter, Ls filter
Standards	DIN/ISO/JIS/ASME/MOTIF
Parameters	DIN/ISO: Ra, Rq, Rz, Rmax, Rp, Rv, Rpk, Rk, Rvk, Mr1, Mr2, A1, A2, Vo, Rt, R3z, R _{Pc} , R _{mr} (3x), HSC, RSm, Rsk, Rdc, Rdq, Rku, Pa, Pt, Pmr (3x), Pdc, Wa, Wq, Wt, WSm, Wsk, JIS: Ra, Rz, RzJIS94, Sm, S, ASME: R _{pA} , R _{pm} MOTIF: R, AR, Rx, W, AW, Wx, Wte, CR, CF, CL, NR, NCRX, NW, CPM
Cutoff <i>l_c</i> (as per ISO/JIS):	0.25 mm, 0.8 mm, 2.5 mm, automatic
Traversing lengths <i>l_t</i> (as per ISO/JIS)	1.75 mm, 5.6 mm, 17.5 mm, automatic, free entry
Traversing lengths (as per MOTIF)	1 mm, 2 mm, 4 mm, 8 mm, 12 mm, 16 mm
Evaluation lengths <i>l_m</i> (as per ISO/JIS)	1.25 mm, 4.0 mm, 12.5 mm
Number <i>n</i> of sampling lengths (as per ISO/JIS):	selectable: 1 to 5
Short cutoff (as per ISO/JIS)	selectable
Measuring speed	0.2 mm/s; 1 mm/s
Profile resolution	standard probe arm length ±250 µm = 8 nm, ±25 µm = 0.8 nm
Measuring range	double probe arm length: ±500 µm = 16 nm
Languages	15, 3 of them Asian
Memory	Max. 30 profiles, max. 40,000 results
Other	lock/code number protection, date/time, integrated printer, dynamic calibration function

Drive Unit SD 26	
Traversing length	26 mm
Measuring speed	0.2 mm/s; 1 mm/s
Positioning speed in X	5 mm/s
Height adjustment in Z	7.5 mm, motorized
Positioning speed in Z	2 mm/s
Zero setting of probe system	Automatically to zero value or to specified value in the probe measuring range
Inclination adjustment	±1.5° (alignment function with user guidance in the evaluation unit)
Temperature (storage)	-15° C to +55° C
Temperature (operation)	+5° C to +40° C
Rel. humidity	30% to 85%, non-condensing
Weight	M 400: approx. 1.0 kg SD 26: approx. 0.9 kg
Interfaces	USB Slave, MarConnect (RS232)
Wide-range AC adapter	90 V to 264 V

MarSurf M 400 C Set



- **Cable connection** between evaluation unit and drive unit
- **Skidless tracing** with high precision probe system
- **Fast probe arm** change due to magnetic probe arm holder
- **Protection from damage**
- **Only a few seconds of setting time** required due to motorized height adjustment of the drive unit with automatic zero setting
- **Flexible handling** with cable-free Bluetooth connection
- **Concise, clear and easy** due to brilliant color display for the depiction of results and operator guidance
- **Mobile use** due to operation with AC adapter or built-in battery
- **Internationally up to date** with all common parameters as per ISO, JIS, ASME, many integrated languages
- **Documentation with quality** with integrated thermal printer for printout of profile and results
- **Standardized measuring point density** despite increased measuring speed

(See also brochure MarSurf M 400)

MarSurf M 400 C Set	
Profile determination	Primary, waviness and roughness profile
Probe	Inductive skidless probe system with exchangeable probe inserts, 2 µm probe arm, measuring force approx. 0.7 mN (standard)
Filters (as per DIN/JIS)	Gaussian filter, Ls filter
Standards	DIN/ISO/JIS/ASME/MOTIF
Parameters	DIN/ISO: Ra, Rq, Rz, Rmax, Rp, Rv, Rpk, Rk, Rvk, Mr1, Mr2, A1, A2, Vo, Rt, R3z, R _{Pc} , R _{mr} (3x), HSC, RSm, Rsk, Rdc, Rdq, Rkn, Rku, Pa, Pt, Pmr (3x), Pdc, Wa, Wq, Wt, WSm, Wsk, JIS: Ra, Rz, RzJIS94, Sm, S, ASME: RpA, Rpm, MOTIF: R, AR, Rx, W, AW, Wx, Wte, CR, CF, CL, NR, NCRX, NW, CPM
Cutoff <i>lc</i> (as per ISO/JIS):	0.25 mm, 0.8 mm, 2.5 mm, automatic
Traversing lengths <i>Lt</i> (as per ISO/JIS)	1.75 mm, 5.6 mm, 17.5 mm, automatic, free entry
Traversing lengths (as per MOTIF)	1 mm, 2 mm, 4 mm, 8 mm, 12 mm, 16 mm
Evaluation lengths <i>lm</i> (as per ISO/JIS)	1.25 mm, 4.0 mm, 12.5 mm
Number <i>n</i> of sampling lengths (as per ISO/JIS):	selectable: 1 to 5
Short cutoff (as per ISO/JIS)	selectable
Measuring speed	0.2 mm/s; 1 mm/s
Profile resolution Measuring range	standard probe arm length ±250 µm = 8 nm, ±25 µm = 0.8 nm double probe arm length: ±500 µm = 16 nm
Languages	15, 3 of them Asian
Memory	Max. 30 profiles, max. 40,000 results
Other	lock/code number protection, date/time, integrated printer, dynamic calibration function

Drive Unit SD 26	
Traversing length	26 mm
Measuring speed	0.2 mm/s; 1 mm/s
Positioning speed in X	5 mm/s
Height adjustment in Z	7.5 mm, motorized
Positioning speed in Z	2 mm/s
Zero setting of probe system	Automatically to zero value or to specified value in the probe measuring range
Inclination adjustment	±1.5° (alignment function with user guidance in the evaluation unit)
Temperature (storage)	-15° C to +55° C
Temperature (operation)	+5° C to +40° C
Rel. humidity	30% to 85%, non-condensing
Weight	M 400 C: approx. 1.0 kg SD 26 C: approx. 0.9 kg
Interfaces	USB Slave, MarConnect (RS232)
Wide-range AC adapter	90 V to 264 V

Scope of delivery

- Evaluation unit MarSurf M 400 C
- Drive unit MarSurf SD 26 C incl. probe system BFW 250
- Standard probe arm (6852403)
- 1 thermo paper roll
- Wide-range AC adapter mit 3 adapters
- 2 x USB cables (to connect to PC and for use with cable)
- Operating instructions

All items are delivered in a practical carrying case.

MarSurf M 400 C Set

Order no. 6910412



MarSurf XR 1

Easy Measurement of Roughness and Waviness



With **MarSurf XR 1** you enter into the top class of surface metrology from Mahr. Whether in the measuring room or in production, the PC-based unit provides all common surface parameters and profiles of international standards.

Several drive units can be connected to the evaluation unit via *Bluetooth* or cable connection.

Clear, well-arranged symbols and convenient user aids simplify the handling of this powerful product. Decades of experience in surface metrology and modern, cutting-edge technology are united in the **MarSurf XR 1**.

MarSurf XR 1 at **Mahr** means future-oriented roughness software.

Features

The roughness measurement software has the following features:

- Over 80 surface parameters for R, P, W profiles according to current standards, ISO/JIS or MOTIF (ISO 12085) selectable
- Band pass filter L_s according to current standards, L_s can also be switched off or freely varied
- Extensive measuring records
- Quick&Easy measuring programs can be quickly created in a user-guided function
- Automatic function for the selection of cutoff and measuring length according to standards (patented)
- Different calibration methods are supported (static and dynamic) with specification of parameters R_a or R_z
- Maintenance and calibration intervals are adjustable
- Many measuring station configurations are possible for each individual application case
- System flexibility due to different options
- Different user levels protect from erroneous use of the unit and ensure that unauthorized users cannot operate the unit

The evaluation software described here can be expanded as desired. The options available are described on the following pages.

MarSurf XR 1

with Drive Unit MarSurf RD 18 and Measuring Stand ST-G



Measuring station for roughness measurements with drive unit MarSurf RD 18 and skidded probe PHT 6-350. This measuring station is characterized by easy and uncomplicated handling. All surface parameters based on roughness depth are available. The characteristics of the evaluation software

Drive Unit MarSurf RD 18

- Tracing direction lengthwise
- Traversing length adjustable in MarSurf XR 1 as per DIN/ISO: 1.75 mm, 5.6 mm, 17.5 mm as per EN ISO 12085: 1 mm, 2 mm, 4 mm, 8 mm, 12 mm, 16 mm
- Tracing speed: 0.5 mm/s
- Dimensions dia. 24 mm, L = 112 mm

Skidded Probe PHT 6-350

System	Single-skid probe
Skid radius	in tracing direction 25 mm, transverse 2.9 mm
Contact point	0.8 mm in front of the stylus
Measuring range	350 µm
Specification	for flat surfaces, bores from 6 mm dia. to 17 mm depth, grooves from 3 mm width min. workpiece length = traversing length + 1 mm

Measuring Station Components

Set "MarSurf XR 1"

- Software and license
- Drive unit adapter
- USB cable

Order no. 6268390



Set "MarSurf RD 18"

- Drive unit MarSurf RD 18
- Probe PHT6-350

Order no. 6910416



All-In-one-PC

Order no. 9058327

May optionally be provided by customer according to Mahr specification

Mount for MarSurf RD 18 on ST-G

Order no. 6910201

XY table CT 120

Order no. 6710529

Measuring stand ST-G

Order no. 6710807

Granite plate 500 mm x 300 mm (L x W) with centered 10 mm T-groove
Measuring column with manual height adjustment range of 300 mm for the drive unit

MarSurf XR 1

with Drive Unit MarSurf SD 26

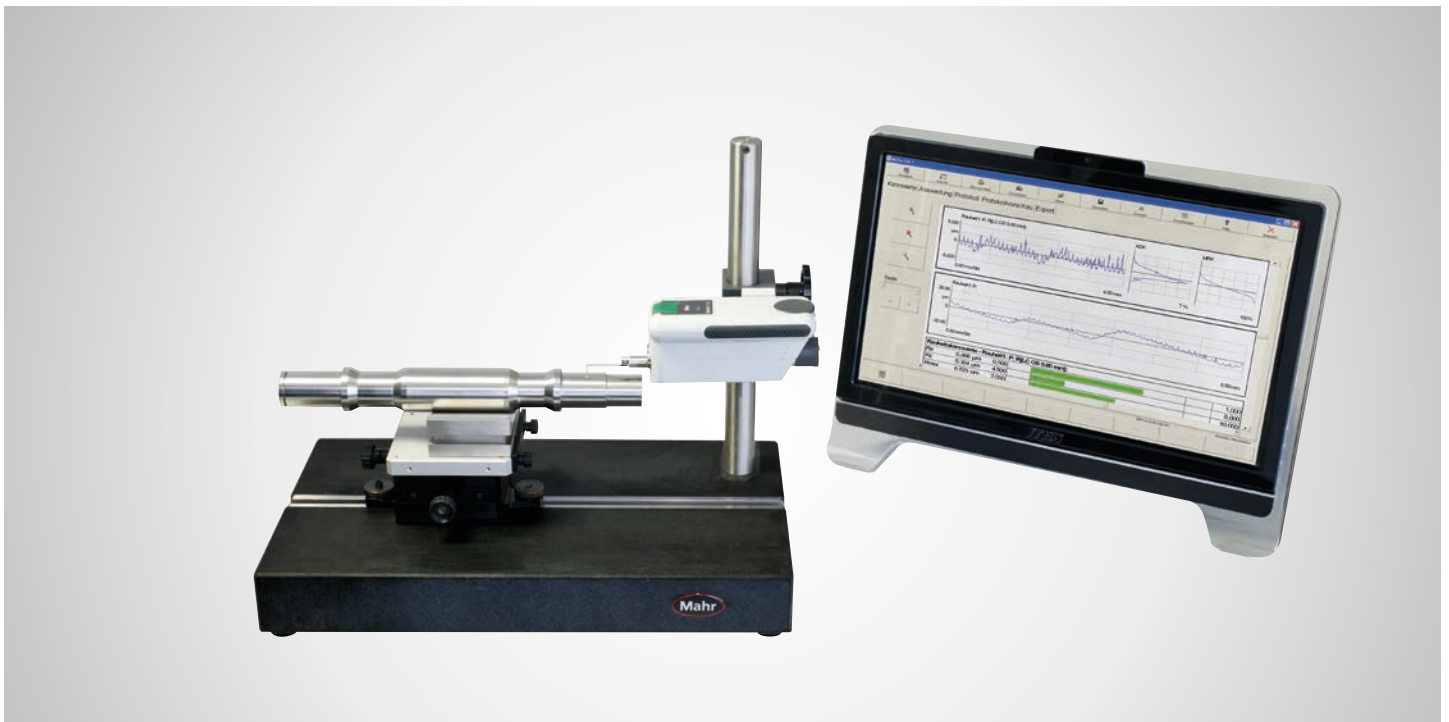

Measuring station for the measurement of roughness depths, P profile and waviness with the drive unit MarSurf SD 26 and the skidless probe system BFW 250.

Special features of this measuring station include:

- Automatic zero setting
- Fast probe arm change without tools

Drive Unit MarSurf SD 26 incl. Probe System

- The **MarSurf SD 26** drive unit with built-in datum plane for precise measurement over up to 25.4 mm (1 inch)
- Rz residual values < 30 nm when tracing speed 0.1 mm/s
- Can be used horizontally, vertically and upside down
- Motorized height adjustment of the drive unit with automatic zero setting
- Measuring length 26 mm
- Measuring speed in 0.1 up to 1 mm/s
- Positioning speed in X 5 mm/s
- Height adjustment Z 7.5 mm, motorized
- Positioning speed in Z 2 mm/s
- **Skidless probe system BFW Set**
 - Measuring range $\pm 250 \mu\text{m}$
 - $\pm 500 \mu\text{m}$ (with double probe arm length)
 - Low tracing force of approx. 0.7 mN
 - High probe linearity < 1 %
 - Fast probe arm change due to magnetic probe arm holder

Measuring Station Components

Set "MarSurf XR 1"

- Software and license
- Drive unit adapter
- USB cable

Order no. 6268390



Set "MarSurf SD 26"

- Drive unit MarSurf SD 26
- Probe BFW-250

Order no. 6910415



All-In-one-PC

Order no. 9058327

May optionally be provided by customer according to Mahr specification

Mount for MarSurf SD 26 on ST-G

Order no. 6910436

XY table CT 120

Order no. 6710529

Measuring stand ST-G

Order no. 6710807

- Granite plate 500 mm x 300 mm (L x W) with centered 10 mm T-groove
- Measuring column with manual height adjustment range of 300 mm for the drive unit

MarSurf XR 1

with Drive Unit MarSurf GD 26



- Skidless tracing with highly precise probe system
- Fast probe arm change due to magnetic probe arm holder without tools
- X axis with scale for reproducible positioning and contour measurement
- Robust metal housing provides protection for use close to production
- Only a few seconds of set-up time required through motorized height adjustment of the drive unit with automatic contacting
- Flexible use due to position-independent orientation
- Standardized measuring point density at high speed
- Optimized for stationary and mobile use

Recommended measuring station

Components:

- MarSurf XR 1 Standard Set
- MarSurf GD 26 Set
- MarSurf MI 500 Set
- All-in-one-PC
- Measuring stand ST-G with 10 mm groove and cross table CT 120
- Mount MarSurf GD 26 on ST-G

Technical Data

MarSurf XR 1 with GD 26	
Measuring path	26 mm (1.02 in)
Measuring range	± 250 µm (± 10,000 µin) with standard probe arm (up to ± 750 µm (30,000 µin))
Measuring speed	0.1 mm/s (0.004 in/s) to 1.0 mm/s (0.04 in/s) adjustable
Positioning speed in X	5 mm/s (0.2 in/s)
Height adjustment Z	7.5 mm (0.3 in), motorized
Positioning speed in Z	2 mm/s (0.08 in/s)
Zero setting of probe system	Automatically to zero or nominal value in probe measuring range
Inclination adjustment	±1.5°
Temperature (storage)	-15° C to +55° C (+5° F to +131° F)
Temperature (operating)	+5° C to +40° C (41° F to 104° F)
Rel. humidity	30 % to 85 %, non-condensing
Weight	approx. 1.3 kg
Drive unit can be used in horizontal, vertical and upside down position)	



MarSurf XR 1

Application Examples

Application: Knee Joint



Measurement of a knee joint
with drive unit MarSurf RD 18 and skided probe system PHTR-100



Application: Stepped Shaft



Measurement of a stepped shaft
with drive units MarSurf SD 26 and MarSurf RD 18

- Connection of several drive units possible



Application: Ship Propeller



Measurement of a ship propeller
with the drive unit MarSurf RD 18 and the probe system PHT 6-350, without cable



MarSurf XR 1

Technical Data

MarSurf XR 1	
Measuring principle	Tactile stylus method
Probes	Skidless tracing - BFW-250 probe Skidded tracing - PHT probe series
Drive units	Skidless tracing - SD 26 / GD 26 Skidded tracing - RD 18, RD 18 C, RD 18 C2
Measuring ranges	SD 26 / GD 26: $\pm 250 \mu\text{m}$ with standard probe arm (up to $\pm 750 \mu\text{m}$) RD 18: $\pm 350 \mu\text{m}$
Profile resolution / resolution for SD 26 / GD 26	
vertical	$\pm 25 \mu\text{m} / 0.7 \text{ nm}$ $\pm 250 \mu\text{m} / 7 \text{ nm}$ $\pm 2,500 \mu\text{m} / 50 \text{ nm}$ approx. 100,000 increments per measuring range
horizontal	Point spacing acc. to DIN EN ISO 3274 (11,200 points for 5,6 mm measuring length; user defined max. 52,000 points possible)
Profile resolution / resolution for RD 18	8 nm
Profile types	SD 26 / GD 26: D-, P-, W-, R-, Rk-, WD-profile, (profile inversion possible) RD 18: R-profile, Rk-profile
Filter types	Gaussian filter (ISO 16610-21) Robust gaussian filter (ISO 16610-31) Spline filter (ISO 16610-22) RC filter (DIN 4768: 1974) Rk filter (DIN EN ISO 13565-1) Robust spline filter (ISO 16610-32) Gaussian filter (DIN EN ISO 11562) Re filter (ISO 12085)
Form elimination	SD 26 / GD 26: ARC filter
Cutoff length	SD 26 / GD 26: 0.08 mm; 0.25 mm; 0.8 mm; 2.5 mm; 8 mm; free input RD 18: 0.25 mm; 0.8 mm; 2.5 mm; free input
Traversing lengths	SD 26 / GD 26: automatic; 0.56 mm; 1.75 mm; 5.6 mm; 17.5 mm; 56 mm; measure to stop; variable RD 18: automatic; 1.75 mm; 5.6 mm; 17.5 mm
Number of sampling lengths	1 to 50 (standard: 5)
Special traversing lengths	0.1 mm up to traverse length, adjustable (0.008 in to 12 in)

Low pass filter	2.5 μm / 8 μm / 25 μm acc. to DIN EN ISO 3274, can be switched off and freely varied
Drive unit speeds (Vt)	SD 26 / GD 26: 0.1 mm/s up to 1.0 mm/s RD 18: 0.5 mm/s
Parameters	
Roughness parameters (RD 18/SD 26/GD 26)	Ra, Rq, Rz (Ry acc. to JIS corresponds to Rz), Rmax, R _{Pc} , Rz (JIS), Rt, Rp, R _p (ASME), R _{pm} , R _v , R _{3z} , R _{Sm} , R _S (cor- responds to S acc. to JIS), R _{sk} , R _{ku} , R _{dq} , R _{lq} , R _{dc} , R _{HSC} , R _{MR*} , R _{MR*} , R _{MR*} , R _{z1max}
Core roughness parameters (RD 18/SD 26/GD 26)	Rk, R _{pk} , R _{vk} , R _{pkx} , R _{vkx} , Mr1, Mr2, A1, A2, Vo, R _{Pm} , R _{tp} , R _{Htp}
P profile parameters (only SD 26/GD 26)	Pa, Pq, Pt, Pp, Pv, P _{Sm} , P _{sk} , P _{ku} , P _{dq} , P _{lq} , P _{dc} , P _{HSC} , P _{Pc} , P _{MR*} , P _{MR*} , P _{MR*} , R _z (JIS 1982), PTIR-1, PTIR-2
W profile parameters (only SD 26/GD 26)	Wa, Wq, Wt, Wp, Wv, W _{Sm} , W _{sk} , W _{ku} , W _{dq} , W _{dc} , W _{MR*} , W _{MR*} , W _{MR*} , WTIR-1, WTIR-2, W _{st}
Motif parameters (ISO 12085) (only SD 26/GD 26)	R, AR, W, AW, Rx, Wx, W _{te} , Nr, N _{crx} , Nw, C _{pm} , CR, CF, CL
ISO 5436 parameters (only SD 26/GD 26)	Pt 5436, D
Lists of parameters	Rz-L, R _p -L, R _{3z} -L, R _{dc} -L, R _{MR} -L, P _{dc} - L, P _{MR} -L, P-step-L
Automatic function	automatic selection of standardized cutoff acc. to DIN EN ISO 3274
Languages	German, English, French, further languages upon request
Software	released for WINDOWS® 7, WINDOWS® 10

* Material ratio calculated with CREF reference or mean line

Subject to technical changes.



MarSurf XR 1

Software and Options

MarSurf XR 1 - Measuring System Order no. 6268390

Including:

Drive unit adapter, USB cable and Software

MarWin EasyRoughness

- "Measuring station" view
- Automatic user logon
- R-profile and parameters
- Rk-profile and parameters
- P-profile and parameters
- W-profile and parameters
- Motif profile and parameters
- D-profile and parameters
- Export as text file (ASCII)
- Profile assistant for USB devices
- MTSurf for RD 18 and SD 26

New:

- Tolerance monitoring and display of tolerances in records
- Statistics
- Expansion of the measuring assistant with the function of Levels 2
- User administration for logging on and administering users with different rights
- Starting mpr program using function keys

Additional Option "RoughnessPlus" Order no. 6299366

- Automatic export of profiles, results files and measuring records in PDF format
- Interactive zoom for defining a profile section to be evaluated and recalculating the selected parameters
- Virtual rulers for defining distances in X and Z direction interactively in the profile field and displaying them in the measuring record

Software Option "UserLevel 3" Order no. 6299364

- Multiple measurements
- User level 3 (pre- and post-positioning)
- Automatic programming

MarSurf XR 1

Additional Software Options

Option "Digital I/O" Order no. 6268392

- For all MarWin software
- Digital I/O box with 8 inputs / 8 outputs
- License "Digital I/O" and brief guide
- Remote control e.g. by a PLC for the integration of the MarWin measuring station into a manufacturing process
- Execution of measurements

Option "QS-STAT" Order no. 6292268

- Simple export of features acc. to Q-DAS
- Support of 31 AutoKeys

Option "QS-STAT Plus" Order no. 6292271

- Simple export of features acc. to Q-DAS
- Manual
- Possibility to change e.g. type, length, description
- Possibility to integrate customer requirements and measuring programs

Option "Dominant Waviness" Order no. 6292203

- Acc. to VDA 2007: 2007-02
- Calculable WD parameters: WDSm, WDc and WDt

Option "Profile Processing" Order no. 6292269

- The option is divided into 3 areas of operation:
 - a) Edge filter
With this roughness measurement function, areas can be hidden that should not be included in the analysis.
 - b) Profile editing
With this function, profiles can be edited, such as grooves or tips cut out, ball simulations, mirroring of profiles, rotating profiles, inserting additional areas etc.
 - c) Stitching profiles
With this function, two or more profiles can be stitched together to form one new profile.

Option "User-Defined Parameters" Order no. 6292270

- With this option, a new parameter group can be created in the products MarSurf XR 1, MarSurf XR 20 or MarSurf XCR 20.

The corresponding surface parameters can be programmed and integrated with regard to customer-specific requirements by the Mahr Application Department.

Option "ISO 13565-3 Parameter" Order no. 6292263

- With this option, the special parameters Rpq, Rmq and Rvq can be evaluated as per ISO 13565-3.

MarSurf XR 1 Software

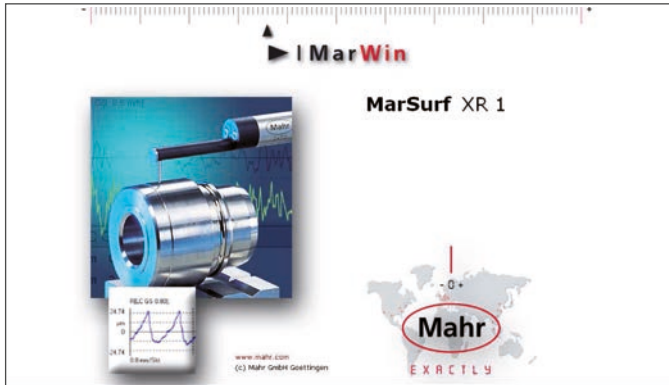

The MarWin software platform enables the user to use a service that is characterized by easy operability for varied measuring and evaluation criteria.

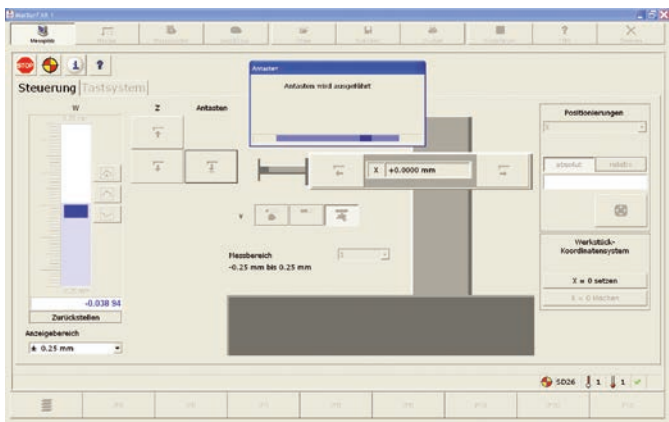

Simple representation of the measuring station with the axes belonging to the measuring set up to allow quick and safe working.

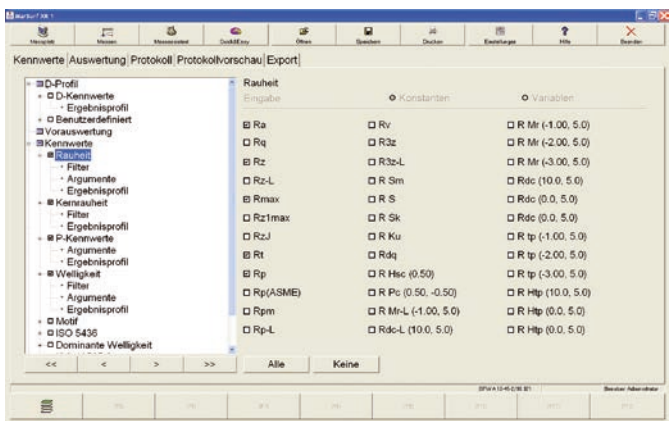

Results, profiles, standardized surface parameters and characteristic curves can be activated by a "click" and output into the test record. The corresponding entries can be directly selected use the tabs: "Surface parameters", "Evaluation", "Measuring record", "Record preview" and offer the user a quick and easy operator control.



Here in the "evaluation" view example, the result with the profile, ADC curve, Mr curve and tolerance control is integrated into the software option "Expanded Measuring Records" up to version 9.X

With Version 10.x and higher, it is integrated in the basic version "EasyRoughness" – the basic software for MarSurf XR 1.

MarSurf XR 1 Software

With the measuring assistant, all measuring conditions can be specifically set for the measuring task. In the option "User level 3", operator prompts assist you in entering e.g. positioning prior to as well as after the measurements.

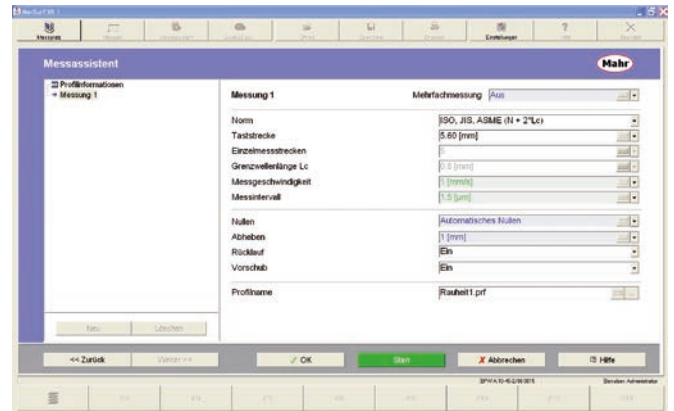

In the "Probe System" view, the drive units as well as the probe arms are specified once. The probe arms can be individually named for easy allocation.

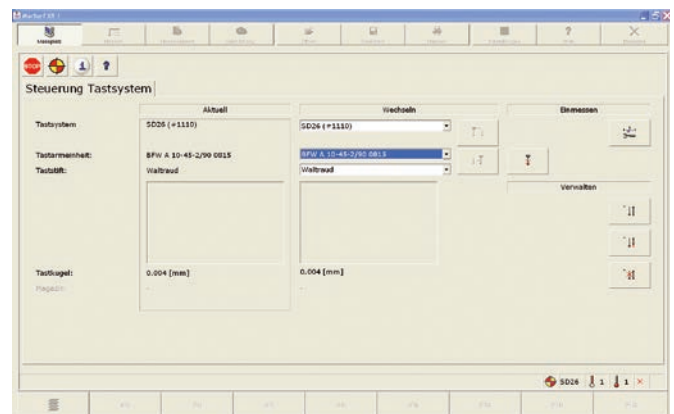

The "Meas. Record" tab enables you to enter profile information into the record header.

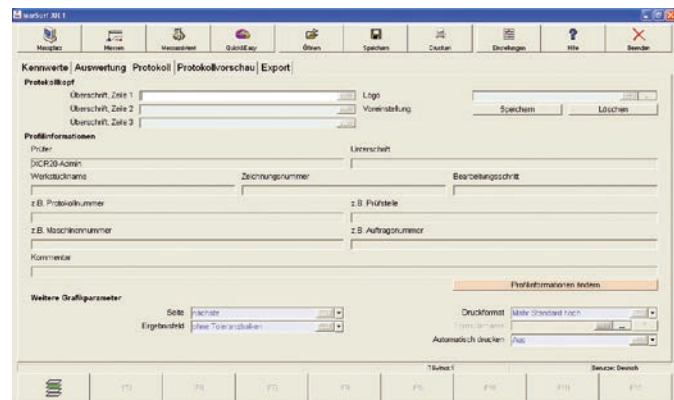

Excerpt from the "Roughness Plus" option. Virtual rulers for the interactive specification of distances in X and Z direction in the profile field enable specific profile sections to be observed.



MarSurf XR 1

Data Transfer from Drive Unit to PC

- Connection of any number of drive units using a drive unit adapter

Alternatively:

- Drive units MarSurf RD 18 and MarSurf SD 26 can be connected to the PC via the *Bluetooth* interface. Connectivity must only be established once. When starting a measuring program, the drive unit linked to the program immediately starts the measuring run.





Probe Arms for Drive Units MarSurf SD 26 / GD 26

Probe System BFW-250 Integrated in MarSurf SD 26

Probe System BFW-250 Integrated in MarSurf SD 26	
Measuring range	±250 µm (for 45 mm probe arm length) ±500 µm (for 90 mm probe arm length)
Low tracing force of	approx. 0.7 mN
High probe linearity	< 1%

Magnetic probe arm support for easy exchange of probe arms also provides additional probe arm protection.



Probe arm BFW A 10-45-2/90°

Probe arm BFW A 10-45-2/90° for bores from dia. 11 mm on	Order no. 6852403
Stylus tip radius / material	2 µm / diamond
Opening angle of stylus tip	90°
Measuring range	±250 µm
Length A (length below probe arm)	8.0 mm
Length B (length up to center of support)	36.5 mm
For use with bores from dia. 11 mm on	approx. 30 mm
Same probe arm with 5 µm 90° diamond	Order no. 6852419
Same probe arm with 2 µm 60° diamond	Order no. 6852418

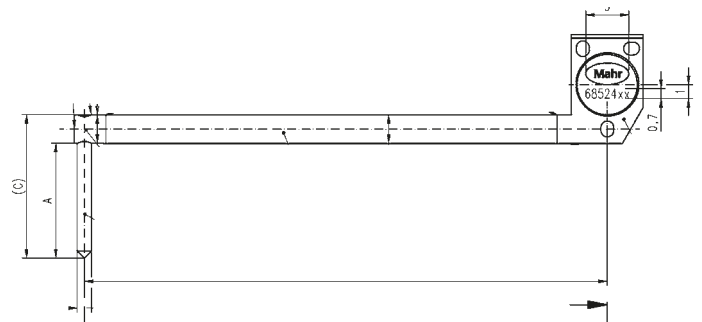

Probe arm BFW A 0,7-45-2/90°

Probe arm BFW A 0,7-45-2/90° for bores from dia. 0.9 mm on	Order no. 6852408
Stylus tip radius / material	2 µm / diamond
Opening angle of stylus tip	90°
Measuring range	±250 µm
Length below the probe arm	0.1 mm
Length up to center of support	36.5 mm
For use with dia. bores from dia. 0.9 mm on bores from dia. 2.5 mm on	approx. 10 mm approx. 30 mm
Same probe arm with 5 µm 90° diamond	Order no. 9057325
Same probe arm with 2 µm 60° diamond	Order no. 9055506

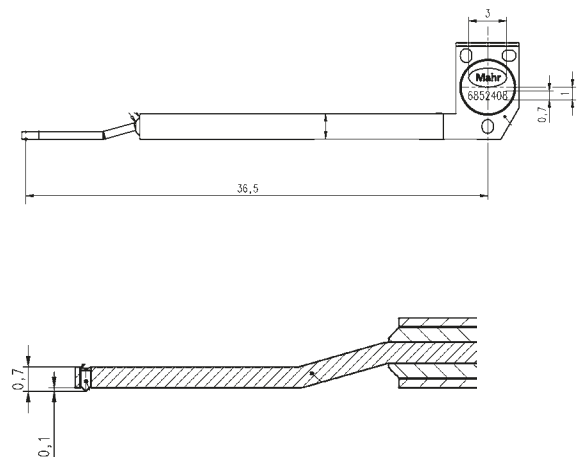

Probe Arms for Drive Units MarSurf SD 26 / GD 26

Probe arm BFW A 1.4-45-2/90°

Probe arm BFW A 1.4-45-2/90° for bores from dia. 1.5 mm on	Order no. 6852407
Stylus tip radius / material	2 µm / diamond
Opening angle of stylus tip	90°
Measuring range	±250 µm
Length A (length below probe arm)	0.2 mm
Length B (length up to center of support)	36.5 mm
For use with bores from dia. 1.5 mm on	approx. 30.0 mm
Same probe arm with 5 µm 90° diamond	9055816

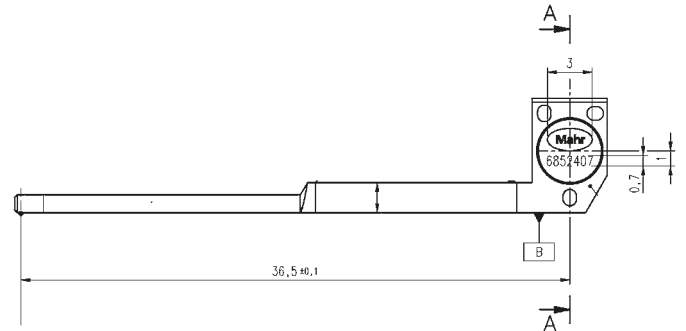

Probe arm BFW A 4-45-2/90°

Probe arm BFW A 4-45-2/90° for bores from dia. 4.5 mm on	Order no. 6852404
Stylus tip radius / material	2 µm / diamond
Opening angle of stylus tip	90°
Measuring range	±250 µm
Length A (length below probe arm)	2 mm
Length B (length up to center of support)	36.5 mm
For use with bores from dia. 4.5 mm on	approx. 30 mm
Same probe arm with 5 µm 90° diamond	9055075
Same probe arm with 2 µm 60° diamond	9056426

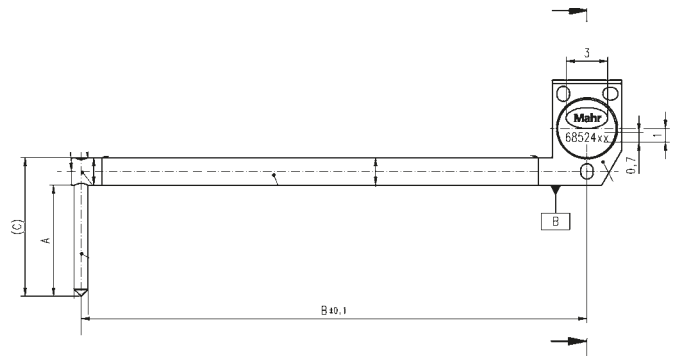

Probe arm BFW A 22-45-2/90°

Probe arm BFW A 22-45-2/90° for recesses up to approx. 20 mm	Order no. 6852412
Stylus tip radius / material	2 µm / diamond
Opening angle of stylus tip	90°
Measuring range	±250 µm
Length A (length below probe arm)	20 mm
Length B (length up to center of support)	36.5 mm
For use with bores from dia. 23 mm on	approx. 30 mm
Same probe arm with 5 µm 90° diamond	9058256
Same probe arm with 2 µm 60° diamond	9010880

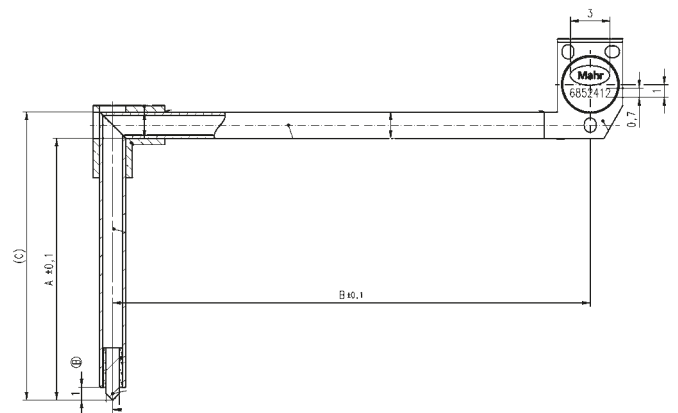

Probe Arms for Drive Units MarSurf SD 26 / GD 26

Probe arm BFW A 10-135-2/90°

Probe arm BFW A 10-135-2/90° for measuring range $\pm 750 \mu\text{m}$, for bores from dia. 11 mm on	Order no. 6852411
Stylus tip radius / material	2 μm / diamond
Opening angle of stylus tip	90°
Measuring range	$\pm 750 \mu\text{m}$
Length A (length below probe arm)	8 mm
Length B (length up to center of support)	126.5 mm
For use with bores from dia. 11 mm on	approx. 123 mm
Same probe arm with 5 μm 90° diamond	9056085

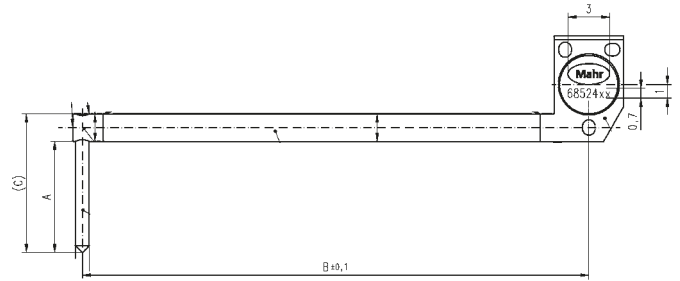

Probe arm BFW A 4-90-2/90°

Probe arm BFW A 4-90-2/90° for measuring range $\pm 500 \mu\text{m}$, for bores from dia. 4.5 mm on	Order no. 6852406
Stylus tip radius / material	2 μm / diamond
Opening angle of stylus tip	90°
Measuring range	$\pm 500 \mu\text{m}$
Length A (length below probe arm)	2.0 mm
Length B (length up to center of support)	81.5 mm
For use with bores from dia. 4.6 mm on	approx. 75 mm
Same probe arm with 5 μm 90° diamond	9054202
Same probe arm with 2 μm 60° diamond	9054230

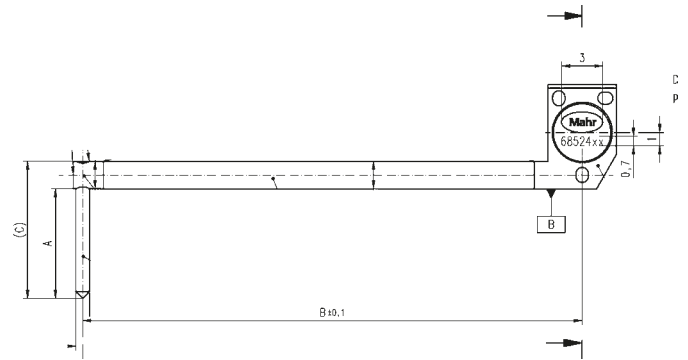

Probe arm BFW A 42-90-2/90°

Probe arm BFW A 42-90-2/90° for recesses up to approx. 40 mm	Order no. 9048671
Stylus tip radius / material	2 μm / diamond
Opening angle of stylus tip	90°
Measuring range	$\pm 500 \mu\text{m}$
Length A (length below probe arm)	40 mm
Length B (length up to center of support)	81.5 mm
For use with bores from dia. 43 mm on	approx. 78 mm

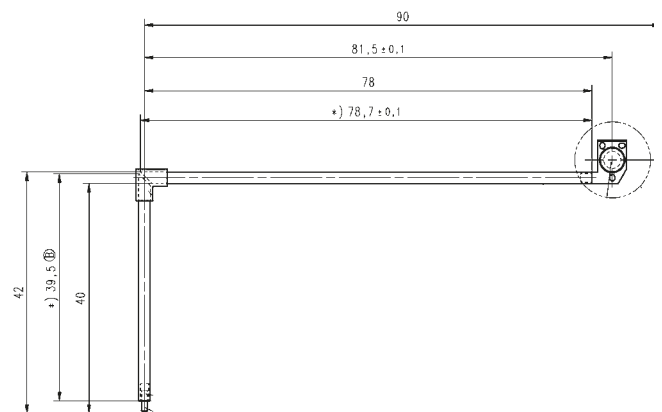

BFW-250

Skid for BFW probe arm	Order no. 6852402
Only for standard probe arm, item no. 6852403	
Total length	46.4 mm

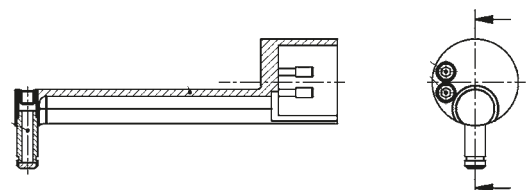

Accessories for MarSurf XR 1

MarSurf SD 26 Set

Set "MarSurf SD 26"

Order no. 6910415

consisting of:

- Drive unit MarSurf SD 26 with datum plane
- Skidless probe system BFW-250 with probe arm BFW A 10-45-2/90°
- AC adapter
- Connecting cable between SD 26 and drive unit adapter
- Operating instructions



MarSurf RD 18 Set

Set "MarSurf RD 18"

Order no. 6910416

consisting of:

- Drive unit MarSurf RD 18
- Skidded probe PHT 6-350 / 2 µm
- Integrated standard
- Height adjustment
- Probe protection
- Probe protection with vee-block base
- End face vee-block
- AC adapter
- Connecting cable between RD 18 and drive unit adapter
- Operating instructions



Accessories

Drive unit adapter

Order no. 7047701

For the connection of two drive units type MarSurf RD 18 and MarSurf SD 26 to a computer.

USB cable

Order no. 8165044

For connecting the drive unit adapter to a PC



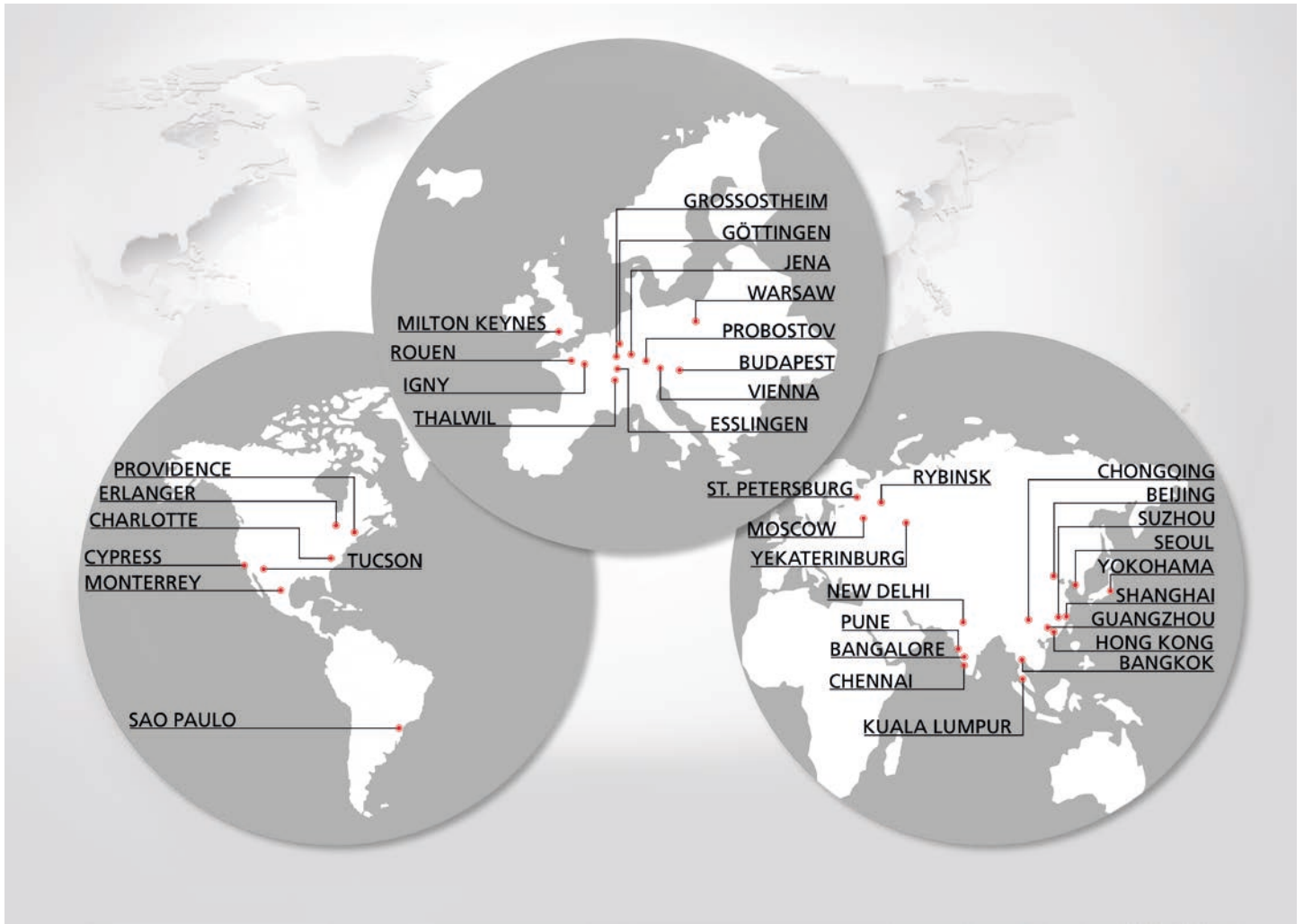

Partner for manufacturing companies worldwide.

Close to our customers.

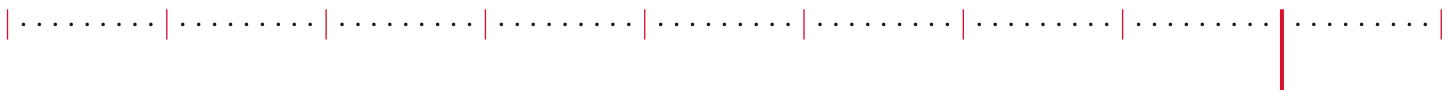

Your Complete Source for
Testing Equipment Since 1969!

www.BergEng.com
Berg Engineering & Sales Company, Inc.

1-847-577-3980
info@BergEng.com